

P.O.P

PLASTICS

I N C O R P O R A T E D

2008
Catalog

Manufacturer of *Rigid PVC*
Literature Holders and
Custom Fabrications

**SAVE MONEY ON ALL YOUR IN-STORE
SIGNING NEEDS!**

1-800-767-7220

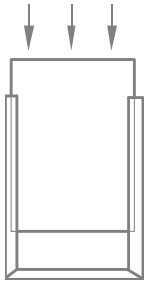

Open-Face



↑ ↑ ↑
INSERT COPY

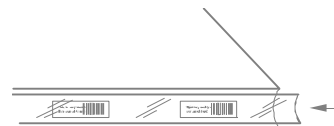
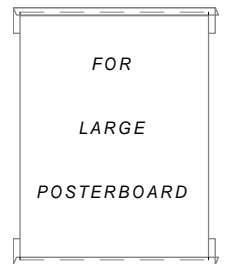
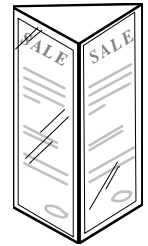

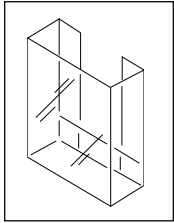

Formed and Scored Literature Boxes 4

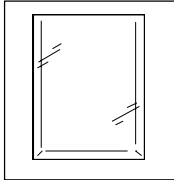

Pockets 5

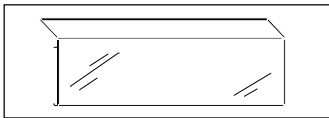

Shelf Hangers and PC Sign Holders 6

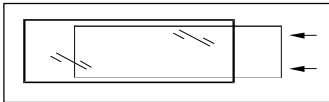

C-Channels: Open-face and Protected-face 7

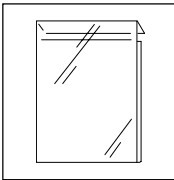

Slotwall Sign Holders 8

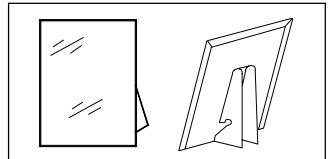

Easel-Back Sign Holders and Brochure Holders 9



Slant Easels and Counter-toppers 10-11

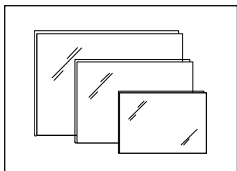

One-Fold and Two-Fold Sign Holders 12-13

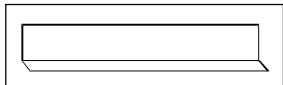

Shelf Retainers 14

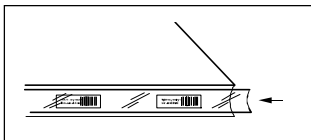

Price Channel Strips and Clear Sheets 15

LITERATURE BOXES

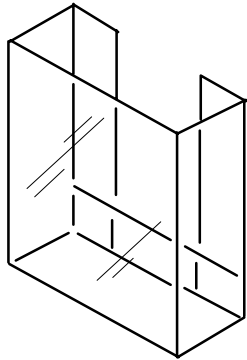

Part#	WxLxH	250	500	1000	2500	5000
LB35	3.5x1.5x.85	.55	.49	.43	.41	.39
LB4	4x5x1.25	.73	.66	.57	.55	.52
LB45	4.5x5x1.25	.75	.68	.59	.57	.54
LB6	6x5x1.25	.94	.85	.74	.70	.67
LB85	8.5x7x1.25	1.38	1.25	1.09	1.03	.98

Custom sizes available at a low cost. Please call for details.

LB SERIES

Formed Literature Box

.015 Clear Rigid Vinyl
w/ 2pc White Foam Adhesive

- Ready to use.. Just peel & stick!
- Great for posting on signs, counter stands and temporary displays.
- Available with Clear adhesive.

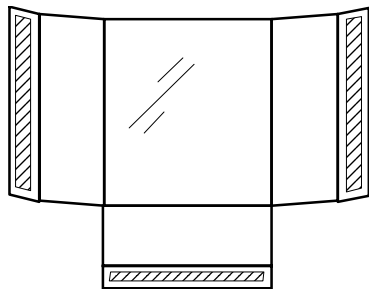
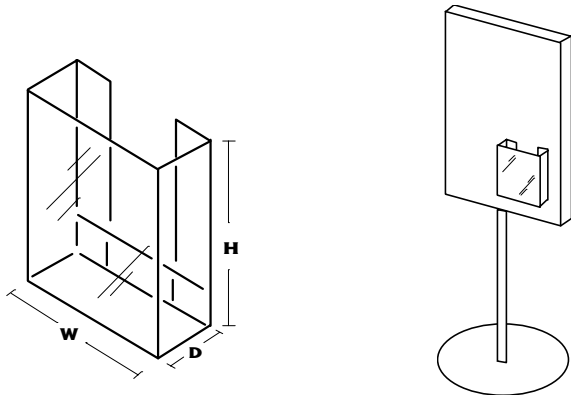

Part #	WxHxD	250	500	1000	2500	5000
LBF35	3.5x1.5x.85	.36	.33	.29	.27	.26
LBF4	4x5x1.25	.60	.54	.47	.45	.43
LBF45	4.5x5x1.25	.65	.59	.51	.49	.46
LBF6	6x5x1.25	.73	.66	.57	.55	.52
LBF85	8.5x7x1.25	.99	.89	.78	.74	.70

Custom sizes available at a low cost. Please call for details.

LBF SERIES

Flat-Scored Literature Box

.015 Clear Rigid Vinyl
w/ 3pc White Foam Adhesive

- Ships FLAT!
- Form at point of use.
- Available with Clear adhesive.

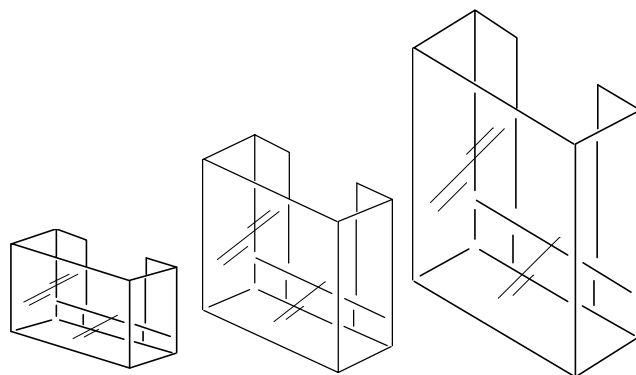

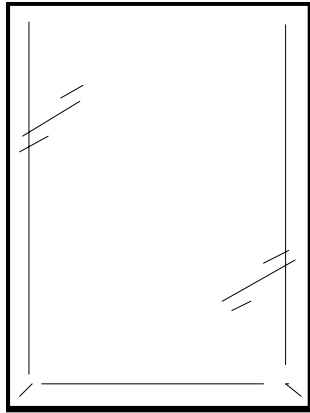

Pro-face / Open-face	WxH	250	500	1000	2500	5000
PPF35 / POF35	3.5 x 5.5	.36	.33	.29	.27	.26
PPF57 / POF57	5 x 7	.44	.40	.35	.33	.31
PPF7 / POF7	7 x 11	.75	.68	.59	.57	.54
PPF8 / POF8	8 x 10	.86	.78	.68	.64	.61
PPF85 / POF85	8.5 x 11	1.04	.94	.82	.78	.74
PPF11 / POF11	11 x 14	1.40	1.27	1.11	1.05	1.00

Custom pockets can be manufactured with no die or set-up charges.

PPF Series - Pro-face Pocket
POF Series - Open-face Pocket
 .015 Clear Rigid Vinyl
 w/ 2pc White Foam Adhesive

- Ready to use.. Just peel & stick!
- Custom sizes can be manufactured at a **very** low cost with a quick delivery time.
- Available as Protected-face or Open-face.
- Both include 2pc twin-stick permanent tape that will stick to any dry surface, indoor or out.
- Rigid and crystal clear ... perfect for posting signs on walls, doors and posts.

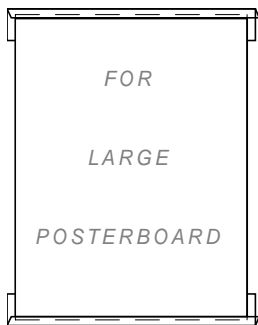
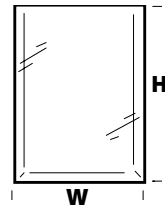
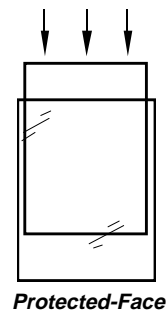
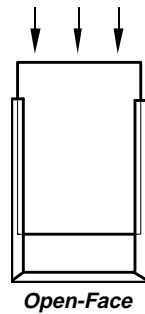

JC SERIES
J-Channel
 .015 Clear Rigid Vinyl
 w/ 1pc White Foam Adhesive

Part#	WxH	250	500	1000	2500	5000
JC12	12" x .50"	.36	.33	.29	.27	.255

Prices are for each piece. Tape included.

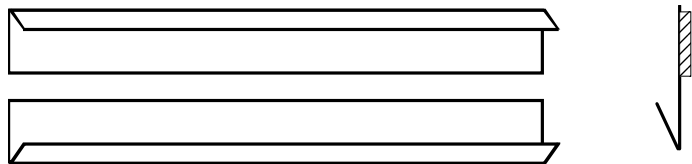

PC SIGN HOLDERS



Part#	WxH	250	500	1000	2500	5000
PCH5	5 x 2	.26	.24	.21	.20	.19
PCH6	6 x 3	.31	.28	.25	.23	.22
PCH12	12 x 3	.55	.49	.43	.41	.39
PCH24	24 x 3	.90	.81	.71	.67	.64

Custom sizes available at a LOW cost!

PCH SERIES

Price Channel Sign Holder

.015 Clear Rigid Vinyl

- Snaps securely into standard 1.25" price channel.
- Hangs below the surface of the shelf.
- Easy to change sale signs or to update prices and product information.



Part#	WxH	250	500	1000	2500	5000
SH5	5 x 2	.31	.28	.25	.23	.22
SH6	6 x 3	.36	.33	.29	.27	.26
SH12	12 x 3	.68	.61	.53	.51	.48
SH24	24 x 3	1.22	1.10	.96	.92	.87

Price includes 1/2" Foam tape or Holes & Dart Clips

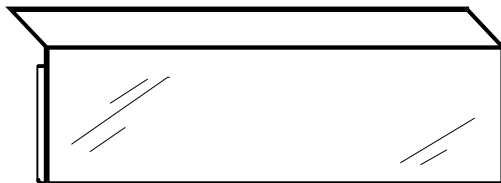

SH SERIES

Shelf Hanger Sign Holder

.015 Clear Rigid Vinyl
w/ tape or dart clips.

- Hangs from any shelf.
- Hang from the top of the shelf using included removable tape or dart clips.
- Can also hang from *under* the shelf!
- Easy to use!

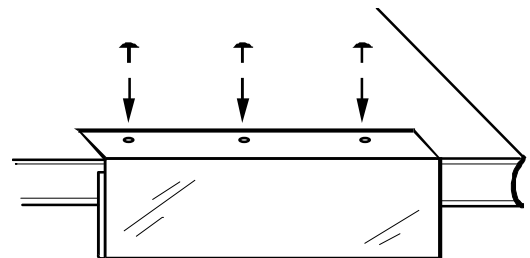

C-CHANNELS

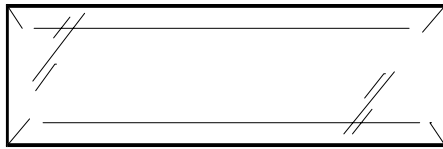

Protected-face C-Channel

Pro-face / Open-face	WxH	250	500	1000	2500	5000
CPF45/COF45	4.5 x 5.5	.47	.42	.37	.35	.33
CPF55/COF55	5.5 x 7	.55	.49	.43	.41	.39
CPF85/COF85	8.5 x 11	1.04	.94	.82	.78	.74
CPF123/COF123	12 x 3.5	.62	.56	.49	.47	.44
CPF125/COF125	12 x 5.5	.73	.66	.57	.55	.52
CPF127/COF127	12 x 7	.78	.71	.62	.59	.56

Custom sizes available at a low cost. Please call for details.

CPF SERIES - Pro-face C-Channel
COF SERIES - Open-face C-Channel

.015 Clear Rigid Vinyl
w/ 2pc White Foam Adhesive

- Ready to use.. Just peel & stick!
- Great for posting on signs, counter stands and temporary or permanent displays.
- Use as a price tag channel.
- Open-face version is easier to use than two J-Channels... you get perfect alignment every time!
- Available with Clear adhesive.

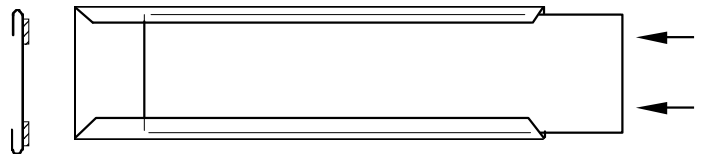

Open-face C-Channel

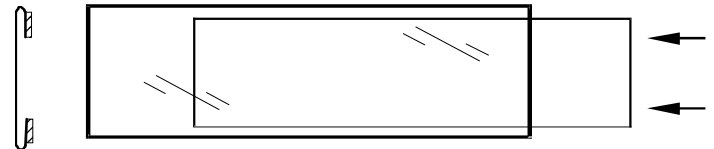

Protected-face C-Channel

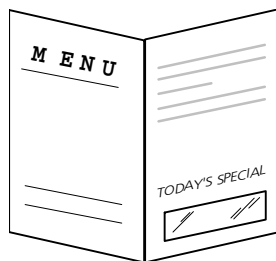
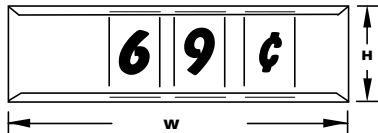

Highlight Daily Specials!



Combine Channels on a display board

SLOTWALL SIGN HOLDERS

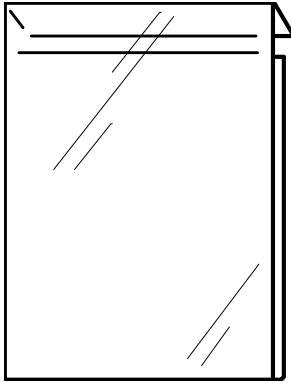

Part#	WxH	250	500	1000	2500	5000
SWH852	8.5 X 2.25	.44	.40	.35	.33	.31
SWH112	11 X 2.25	.62	.56	.49	.47	.44
SWH85	8.5 X 11	1.48	1.34	1.17	1.11	1.05
SWH117	11 X 7	1.17	1.06	.92	.88	.83

Custom sizes available at a low cost. Please call for details.



SWH SERIES

Slotwall Hanger

.030 Clear Rigid Vinyl

- .060 Clear Petg available, please call!
- These inexpensive slotwall sign holders are an excellent acrylic replacement.
- They will not crack if dropped.
- Rigid yet lightweight and easy to ship.
- Can be custom made to your specifications.

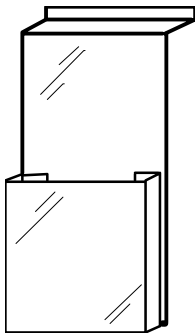

Part#	WxHxD	50	100	250	500	1000
SWB4	4x5x1.25	2.11	1.90	1.66	1.58	1.50
SWB85	8.5x9x1.25	5.46	4.94	4.31	4.10	3.89

Custom sizes available at a low cost. Please call for details.

SWB SERIES

Slot-wall Literature Holders

.020 Clear Rigid Vinyl Box

Attached to a .060 Clear PETG back

- The SWB4 is designed to hold standard brochures.
- The SWB85 holds 8.5x11 information sheets.
- Great for in-store promotion flyers.

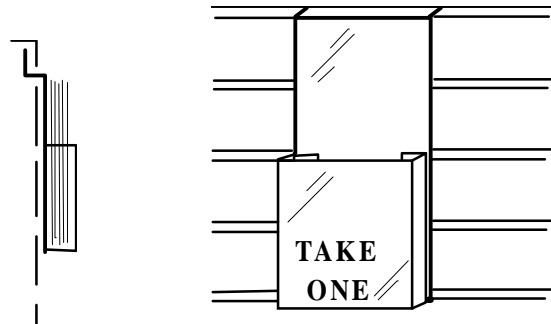

EASEL-BACK SIGN HOLDERS

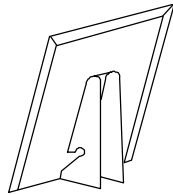
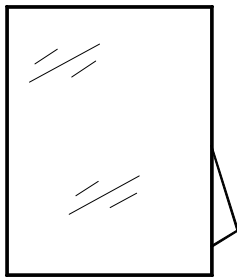

Part#	WxH	250	500	1000	2500	5000
EB85	8.5 x 11	1.68	1.52	1.32	1.26	1.19

Other sizes available! Please call for price and availability.

EB SERIES

Easel-Back Sign Holder

.015 Clear Rigid Vinyl pocket on a 50pt white Easel-Back.

- One of our most versatile sign holders.
- Lightweight and **SHIPS FLAT!**
- Easy to set-up.
- Quality **white** back and easel make this an attractive sign holder for *any* counter!



↑ ↑ ↑
INSERT COPY

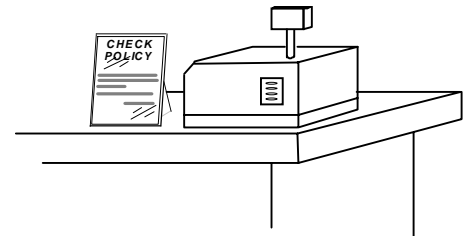

Great as a policy sign holder!

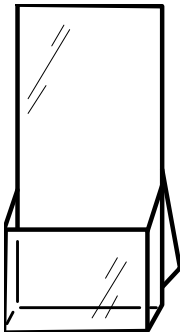

Part#	WxHxD	250	500	1000	2500	5000
EBP4	4 x 8.5 x 1	2.05	1.86	1.62	1.54	1.46
EBP85	8.5 x 11 x 1	3.72	3.36	2.93	2.79	2.65

Has a Last Copy protector! Custom sizes available.. Please call.

EBP SERIES

Easel-Back Pocket

.020 Clear Rigid Vinyl w/ strong 50pt white Easel-back

- **Has a LAST-COPY protector!**
- Easy to set-up and use.
- Lightweight, easy to ship.

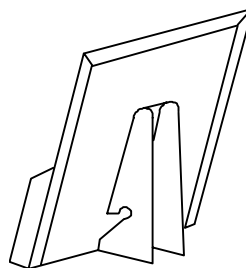

Easy to use Easel-Back

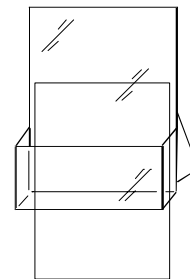

↑ ↑ ↑

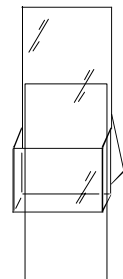

↑ ↑ ↑

Insert Last Copy for product identification after brochures are gone.

COUNTER-TOP SIGN HOLDERS

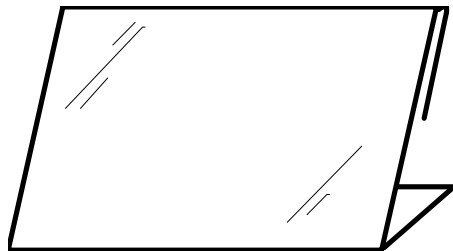

Part#	WxH	250	500	1000	2500	5000
SE35	3.5 x 2.75	.26	.24	.21	.20	.19
SE55	5.5 x 3.5	.44	.40	.35	.33	.31
SE7	7 x 5.5	.73	.66	.57	.55	.52
SE117	11 x 7	1.30	1.18	1.03	.98	.93
SE118	11 x 8.5	1.56	1.41	1.23	1.17	1.11

Custom sizes available at a low cost. Please call for details.

SE SERIES Slant Easel

.030 Clear Rigid Vinyl

- A great Acrylic replacement.
- Will not crack or break if dropped.
- Lightweight, inexpensive to ship.
- Easy to use!

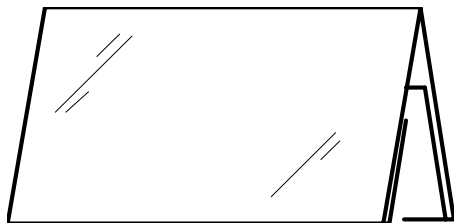
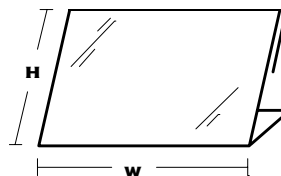

Part#	WxH	250	500	1000	2500	5000
TE55	5.5 x 3.5	.60	.54	.47	.45	.43
TE7	7 x 5.5	.94	.85	.74	.70	.67
TE117	11 x 7	1.56	1.41	1.23	1.17	1.11
TE118	11 x 8.5	1.69	1.53	1.33	1.27	1.20
TE85	8.5 x 11	2.50	2.26	1.97	1.87	1.78

Custom sizes available at a low cost. Please call for details.

TE SERIES Tent Easel

.030 Clear Rigid Vinyl

- Display your insert on both sides.
- Durable, clear material.
- Will "bounce", not crack if dropped.
- Many sizes to choose from.

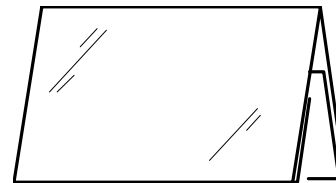
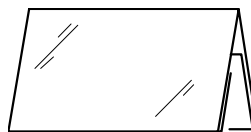

COUNTER-TOP SIGN HOLDERS

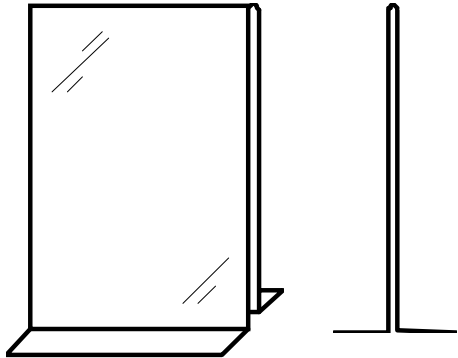

Part#	WxH	250	500	1000	2500	5000
VF5	5 x 7	1.12	1.01	.88	.84	.80
VF85	8.5 x 11	2.34	2.12	1.85	1.76	1.67
VF14	14 x 11	3.33	3.01	2.62	2.50	2.37

Custom sizes available at a low cost. Please call for details.

VF SERIES

Vertical Frame

.030 Clear Rigid Vinyl

- Includes a C-Channel base for added stability.
- Great for the top of "rounders".
- Insert is visible from both sides.

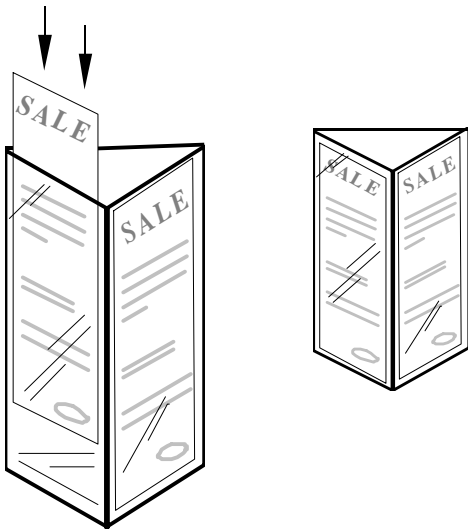

Part#	WxH	250	500	1000	2500	5000
TS35	3.5 x 5.5	1.43	1.29	1.13	1.07	1.02
TS5	5 x 7	1.69	1.53	1.33	1.27	1.20
TS7	7 x 11	3.38	3.06	2.67	2.54	2.41
TS85	8.5 x 11	4.16	3.76	3.28	3.12	2.96

Shipped KD - easy to assemble.. instructions included.

TS SERIES

Tri-side Card Holder

.030 Clear Rigid Vinyl

- Smaller sizes are excellent for restaurant table tops.
- Shipped "flat" for easy handling.
- Insert is visible from 3 sides!

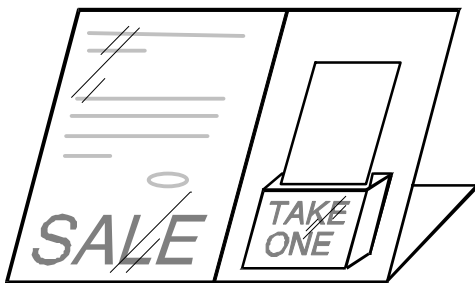

Part#	WxH	50	100	250	500	1000
DE13	13 x 11	5.07	4.58	4.00	3.80	3.61

Custom sizes available at a low cost. Please call for details.

DE SERIES

Display Easel

.060 Clear PETG Easel with .015 pocket and .015 C-Channel

- Display holds an 8.5 x 11 "information sheet" and standard 4 x 8.5 brochures.

ONE-FOLD SIGN HOLDERS

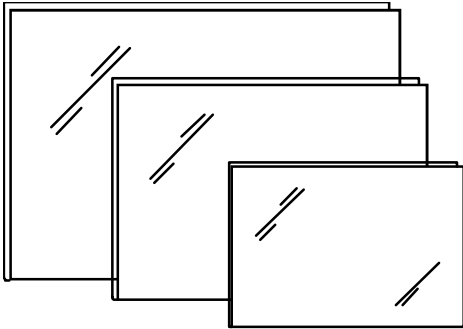

Part#	WxH	250	500	1000	2500	5000
OF25	2.5 x 3.5	.13	.12	.11	.10	.09
OF35	3 x 5	.17	.15	.13	.12	.11
OF55	5.5 x 3.5	.24	.22	.195	.18	.17
OF75	7 x 5	.29	.26	.24	.22	.20
OF85	8.5 x 11	.65	.59	.51	.49	.46
OF11	11 x 7	.60	.54	.47	.45	.43
#11 White Rings each:		.06	.05	.04	.04	.04
Holes:		add .015¢ per hole, per piece				
<i>Custom sizes available at a low cost. Please call for details.</i>						

OF SERIES
One-Fold Sign Holder
 .015 Clear Rigid Vinyl

- Great for all your sign holder needs.
- Use with rings to hang from a basket or wire.
- Use with a "gripper" card holder or price channel "arrow".
- Available with or without holes.

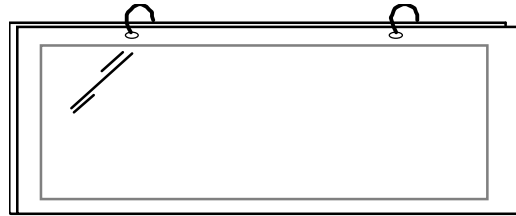

One-fold w/ 2 Holes and 2 Rings

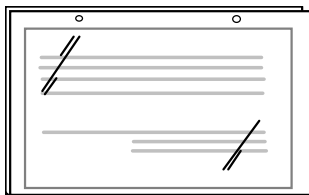

One-fold w/ 2 Holes



One-fold w/ 1 Hole



Two-Fold Sign Holders

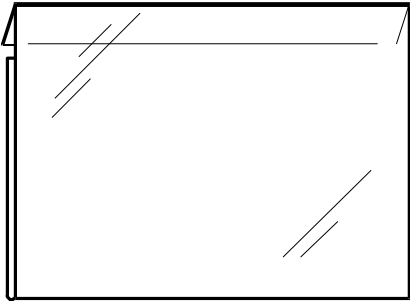

Part#	WxH	250	500	1000	2500	5000
TF5	5.5 x 3.5	.31	.28	.25	.23	.21
TF7	7 x 5.5	.46	.41	.36	.34	.32
TF9	9 x 7	.72	.65	.56	.54	.51
TF117	11 x 7	.75	.68	.59	.57	.54
TF118	11 x 8.5	1.01	.92	.80	.76	.72
TF852	8.5 x 2.25	.31	.28	.25	.24	.23
TF102	10 x 2.25	.36	.33	.30	.28	.26

Custom sizes available at a low cost. Please call for details.

TF SERIES

Two-Fold Sign Holder

.015 Clear Rigid Vinyl

- Rigid, and crystal clear.
- Hang from a wire or fit in any standard price channel.
- Available in many sizes!

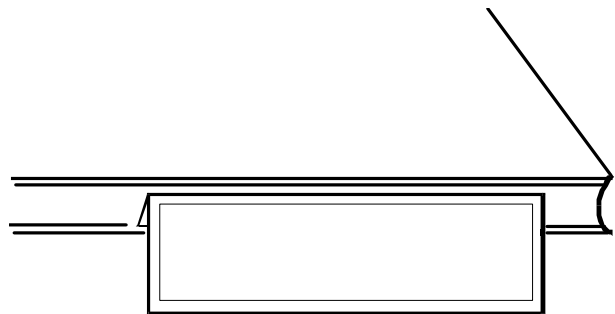

Fits any standard price channel!

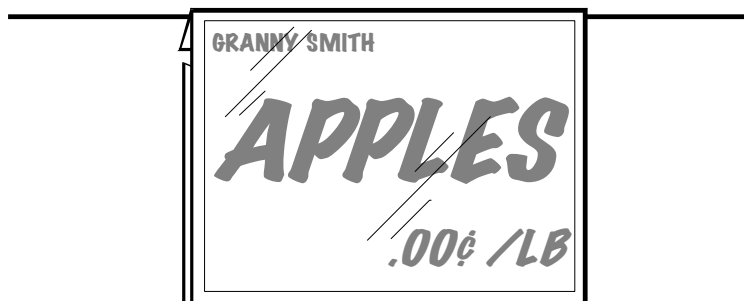

*Makes a great "produce hanger"
Hangs from a wire!*



Side View

SHelf RETAINERS

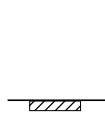
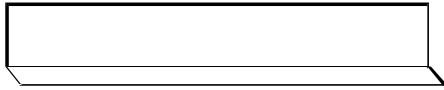

Part#	WxH	250	500	1000	2500	5000
SR6	6 x 1	.26	.24	.22	.21	.19
SR12	12 x 1	.45	.41	.36	.34	.32
SR24	24 x 1	.73	.66	.57	.55	.52

Custom sizes available at a low cost. Please call for details.

SR SERIES Shelf Retainer

.030 Clear Rigid Vinyl
w/ 1pc White Foam Adhesive

- Ready to use.. Just peel & stick!
- Manufactured to any length up to 30"
- Use to keep product separated and on the shelf
- Available with Clear adhesive.

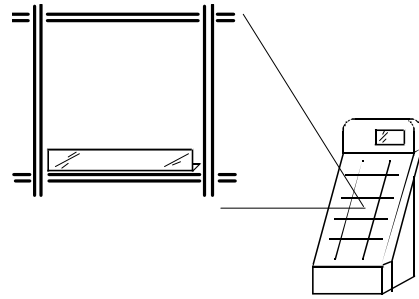

*Use on temporary displays to keep
product in its place!*

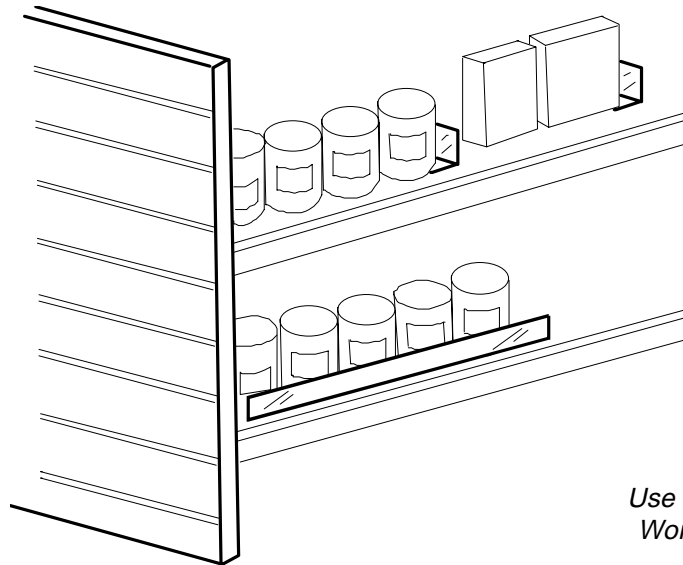

*Use in between product or in front.
Works great on slanted shelves..
keeps product organized!*

STRIPS & SHEETS

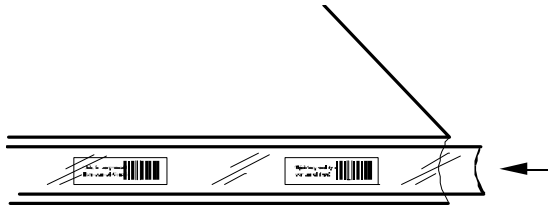

Part#	Size	1000	2500	5000	10M	25M+
PCS2	2 x 1.24	16.00	14.50	12.50	12.00	11.25
PCS3	3 x 1.24	18.25	16.50	14.50	13.65	13.00
PCS12	12 x 1.24	41.60	37.60	32.80	31.20	29.60
PCS24	24 x 1.24	77.00	70.00	61.00	58.00	55.00

Price is per thousand pieces. Custom sizes available.

Price Channel Strips

.010 Clear Rigid Vinyl

- Use with scan tickets or price tags

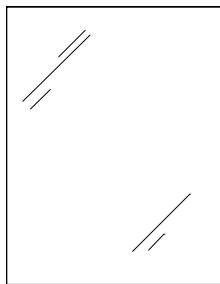

Part#	Size	250	500	1000	2500	5000
CS5	5.5 x 7	.146	.132	.115	.109	.104
CS7	7 x 11	.30	.27	.24	.23	.21
CS8	8 x 10	.25	.23	.20	.19	.18
CS85	8.5 x 11	.32	.29	.25	.24	.23

Custom sizes available at a low cost. Please call for details.

Clear Sheets

.015 Clear Rigid Vinyl

- Use as a sign or page protector!

ORDERING INFORMATION

CALL: 800-767-7220 for customer service or
760-930-1290 Fax: 888-767-1444

Address: 2225 Faraday Avenue Ste. C
Carlsbad CA 92008

P.O.P PLASTICS is a full service plastics manufacturing company. We can shear, die-cut, tape, assemble, screen-print, thermo-fold, and package any custom item you may have in mind. Please call us or fax a rough sketch of what you have in mind, and our design specialists will give you a quote and sample if needed. We will do all we can to help you with your display needs.

NOTICE: The prices herein are published for use by the wholesale industry only.

A confirming Purchase Order containing size and quantities, must be received before we can process any custom order.

Purchaser assumes all risk of liability due to improper use of products.

Copyright © 1994,2008 P.O.P Plastics Incorporated

P.O.P
PLASTICS
INCORPORATED

Call today for a free quote or samples!

1-800-767-7220